

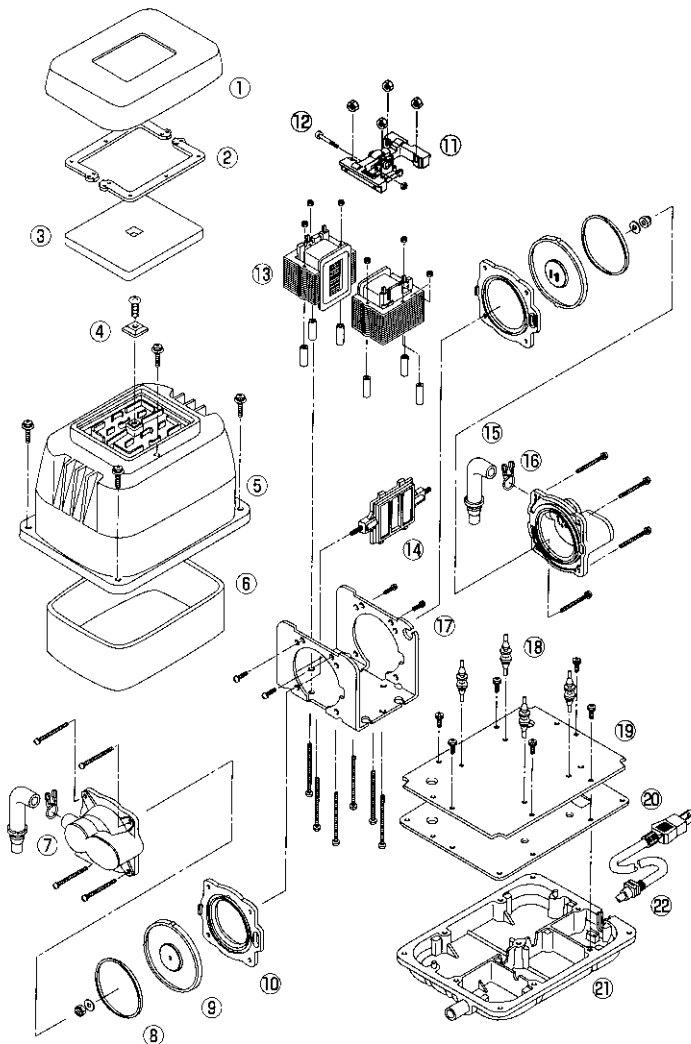

Air pump	Start of production	Discontinuance of production
HP-60	1995/9	—
HP-80	1995/9	—

## HP Series

## STRUCTURE AND PART NAMES



### HP-60/80

- ① Filter Cover
- ② Semi Cover Packing
- ③ Filter
- ④ Fitting Boss
- ⑤ Upper Housing
- ⑥ Sound Absorber
- ⑦ Casing Block
- ⑧ Diaphragm Ring
- ⑨ Diaphragm
- ⑩ Diaphragm Base
- ⑪ SP Switch
- ⑫ Safety pin+Locking collar
- ⑬ Electromagnet
- ⑭ Actuating Rod
- ⑮ L-Tube
- ⑯ Hose Band
- ⑰ Frame
- ⑱ Vibration Control Rubber
- ⑲ Center Plate
- ⑳ Gasket
- ㉑ Lower Housing
- ㉒ Power Cord

**CAUTION**

- Be sure to unplug the pump unit.
- Replace the diaphragms and the valves with new ones at least once a year to one and a half year regularly in order to maintain their initial performance.
- For chamber block replacement, be sure to change both chamber blocks at the same time.
- The rod employs powerful permanent magnets. Therefore, be sure to remove your watch and any other precision machines before operation as they may be affected by the strong magnetic force.
- Do not put the actuating rod close to a magnetic card, magnetic disk or other magnetic media as the data may be destroyed.

**STEP 1****REMOVAL OF THE CHAMBER BLOCKS**

To remove the upper housing.  
(Refer to “**REMOVING UPPER HOUSING**”)  
Remove the sound absorber.  
Pull out the L-tube from the casing block.

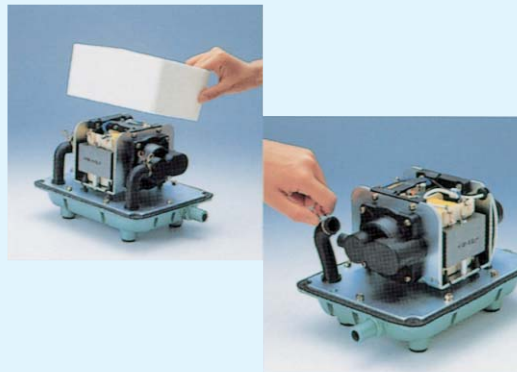
**STEP 2**

Remove the 4 screws holding the chamber block and the casing block.  
(4 screws on each side)

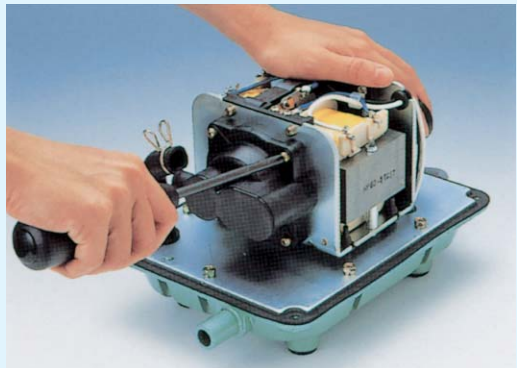
**STEP 3**

Remove 1 U-lock nuts from one side holding the diaphragm mounting block to the rod.

- Use the nut driver to loosen (or tighten) the U-lock nut.



## STEP 4

Remove one of the diaphragm mounting blocks from the actuating rod and pull out the other diaphragm mounting block with the rod. After that, separate the diaphragm mounting block and the rod.

- When pulling out the rod, be sure not to catch the rod projection on the lever of the SP switch.
- If the pump stops automatically, the safety pin must be broken to prevent any further damage to the pump. Be sure all broken pieces are removed from the unit. (See **Step 8**)

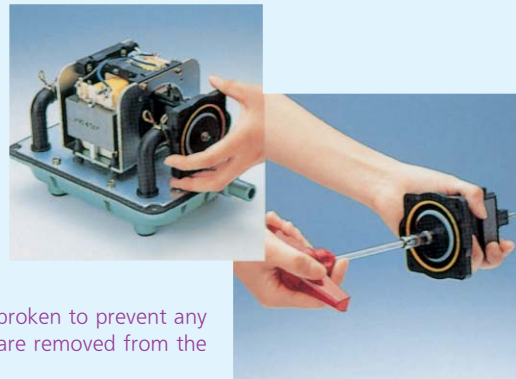

## STEP 5

### FITTING THE CHAMBER BLOCKS

Fit the actuating rod by aligning it with the groove and tighten U-lock nut and flat washer by the nut driver.

- Use new U-lock nut and washer, otherwise, U-lock nut may work loose and cause malfunction.



## STEP 6

Insert the actuating rod into the machine body. Be sure to fit the positioning boss on the diaphragm base into the concave part of the frame stay. Secure the diaphragm mounting block on the other side and tighten washers and U-lock nuts with the nut driver.

Make sure that gap between the actuating rod and the electromagnets is even.

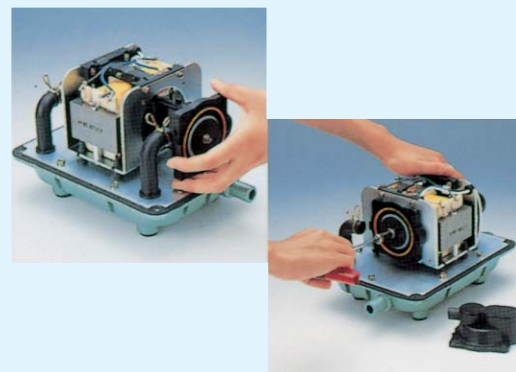

## STEP 7

Mount the casing block with screws (4 screws on each side). And insert L-tube into the nozzle of casing block. Complete the other casing block at the same way.

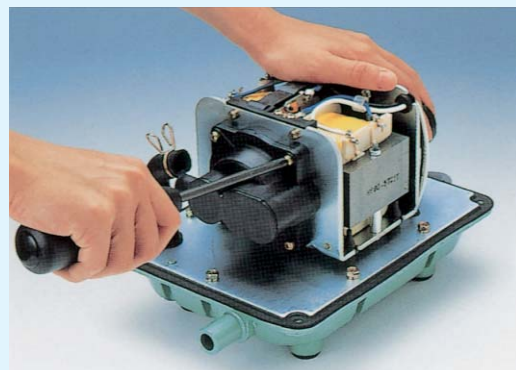

### STEP 8

#### REPLACEMENT OF SAFETY PIN

Check that the broken screw is removed from unit.

- If the broken pin is left inside the unit, it can get caught in between electromagnets and actuating rod, which can cause breakdown.



### STEP 9

Insert a new safety pin through the hole on the terminal side.

(Please Insert safety pin through the spring electrode, L-shaped lever in such order.)

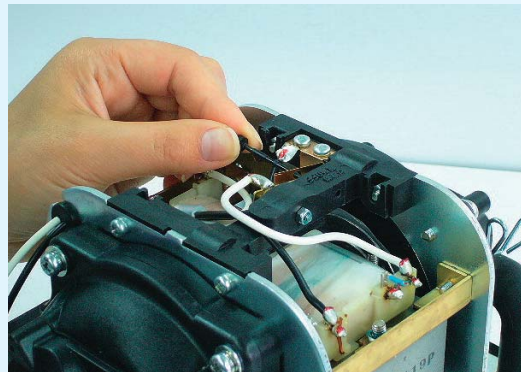

### STEP 10

Install the locking collar from the other side of the terminal and insert it until it clicks.



### STEP 11

This completes the replacement of the safety pin procedure.

Make sure the gaps between L-shaped lever and tab of the actuating rod is even.

- Be careful not to touch the terminal when the power is on, testing the operating conditions as this will result in an electric shock.
- Unplug the pump immediately after the check.





### STEP 12

Install the sound absorber.

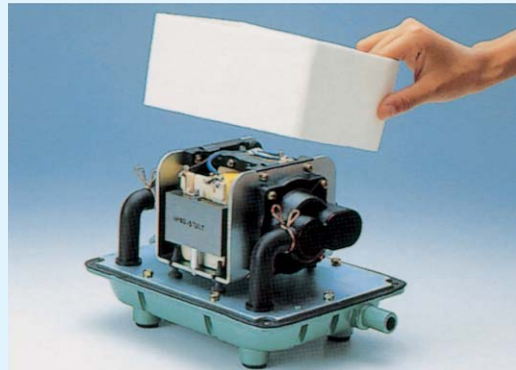

### STEP 13

Place the upper housing back on body.

- Be extremely careful not to catch the sound absorber on the upper housing.

Fasten it with the bolts.

Then, place the filter and filter cover on the upper housing. (Refer to **“FILTER CLEANING AND REPLACEMENT”**)



### ⚠ CAUTION

- Be sure to unplug the pump unit.
- When performing replacement work, the pump body may still be hot and you could get burned. So please wait until the pump has cooled before handling.
- Be sure to remove the chamber block and the actuating rod before replacing the electromagnet.
- It is better to let an experienced technician handle the soldering process. Take precautions against getting burned.

### STEP 1

#### REMOVAL OF ELECTROMAGNET

Cut the wire from terminals on the electromagnets with nippers.

- It is recommended that you make a note of the wiring.

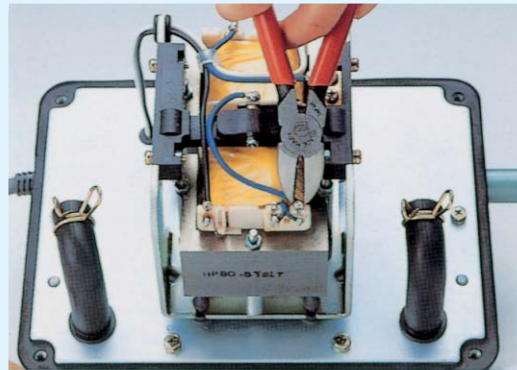

### STEP 2

Loosen the screw, fixing SP switch and remove it .  
(There are hexagonal nuts at SP switch side. Be sure not to lose them as they fall inside the unit.)

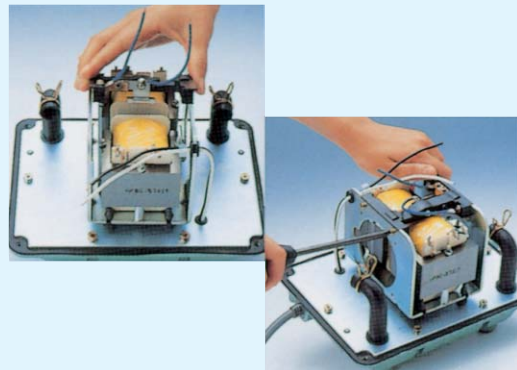

### STEP 3

Remove the hexagonal nuts by the nut driver.  
(7mm wrench)  
Pull out the electromagnets from the pump body.



### STEP 4

#### MOUNTING THE ELECTROMAGNET

Mount new electromagnet in the unit.  
Tighten up hexagonal nuts with nut driver.



### STEP 5

Install the SP switch to the frame with the screws.

- Be careful of the direction of switch lever. (Refer to the pictures)

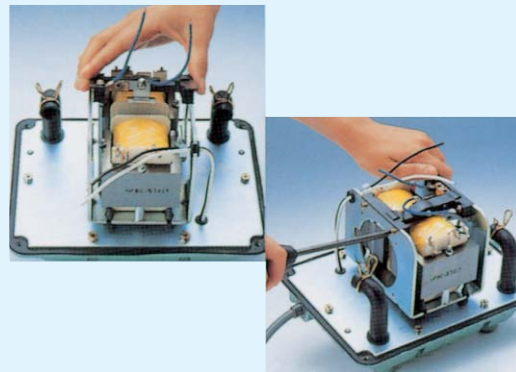

### STEP 6

Insert the wire into the silicon tube, and tie up in a bundle.

Strip the coating off each wire.  
(5-7mm from the end)

Connect the wires to the terminals.

Solder the wires to the terminals.

The wire requires a soldered connection.

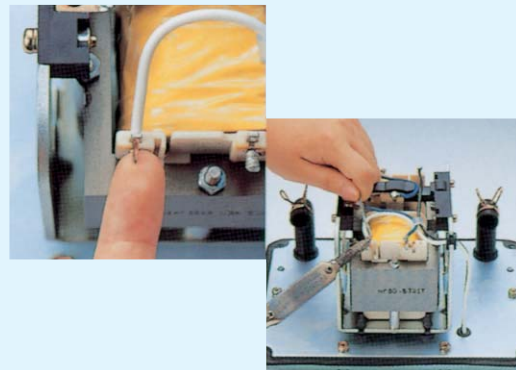

### STEP 7

This completes the electromagnet replacement procedure.

